

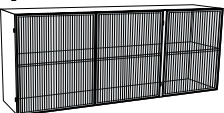





87876 Sideboard San Diego 150x90cm

KARE
DESIGN

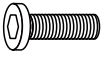
A  X1PC	B  X2PC	C  X1PC	D  8x30MM X2PCS	E  8x10MM X8PCS	F  X2PCS	G  X1PC
--	---	---	--	--	--	---



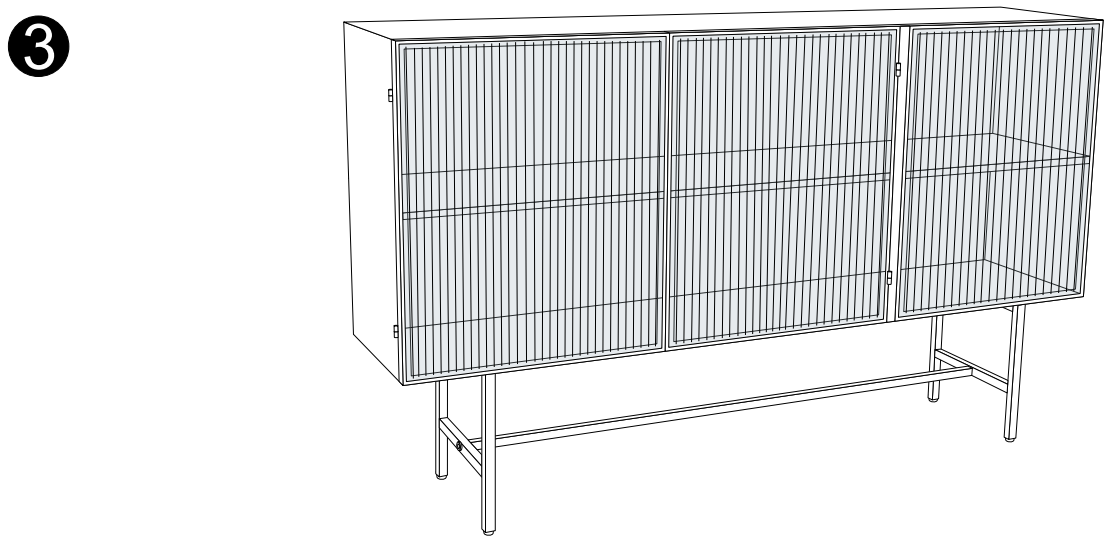
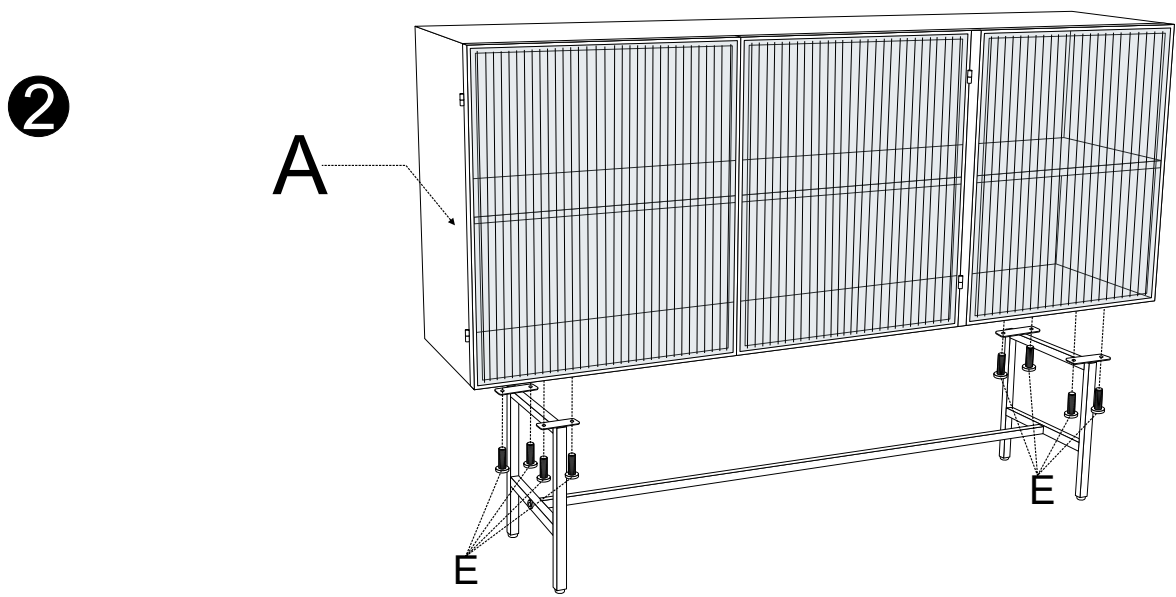
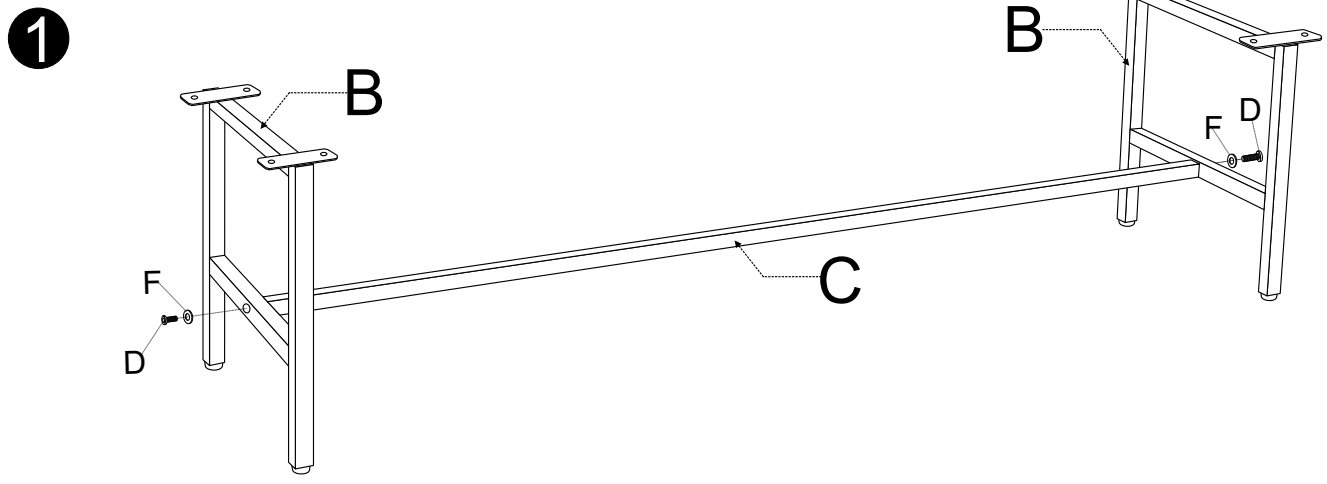

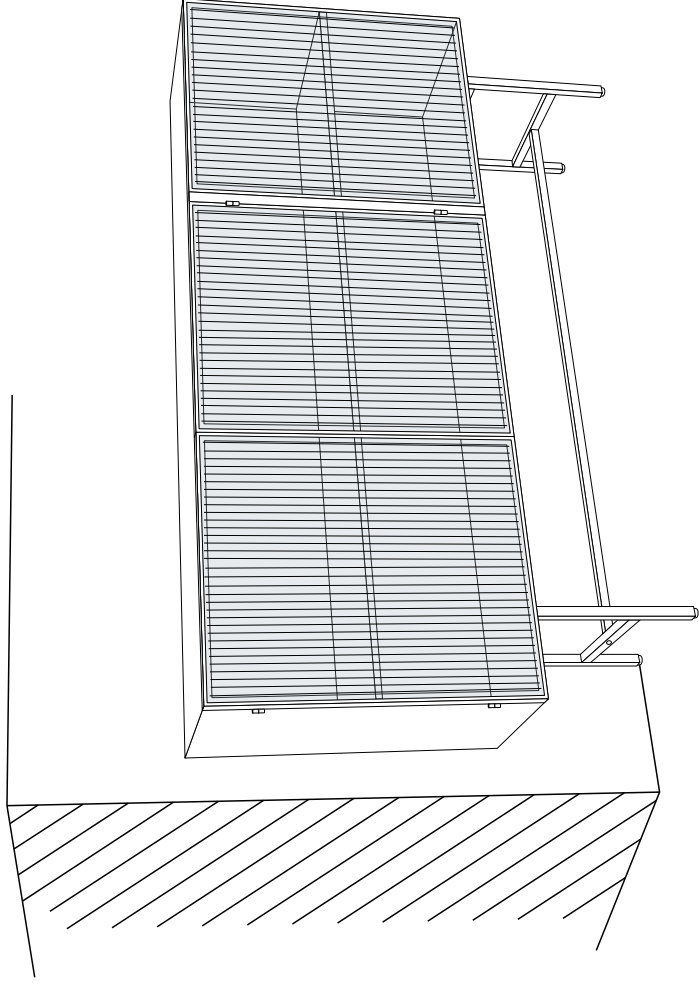

87876 Sideboard San Diego 150x90cm

Anti tilt system

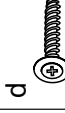

Anti tilt system

 a	 b	 d	 e	1PC	2PC	2PC	2PC
--	--	--	--	-----	-----	-----	-----

