

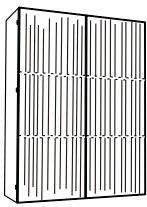

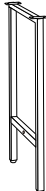

# 87875 Display Cabinet San Diego 90x170cm

**KARE**  
DESIGN

<b>A</b>  X1PC	<b>B</b>  X2PC	<b>C</b>  X1PC	<b>D</b>  8x30MM X2PCS	<b>E</b>  8x10MM X8PCS	<b>F</b>  X2PCS	<b>G</b>  X1PC
---	---	---	---	--	--	---

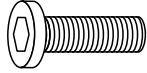
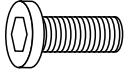
**1**

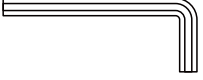
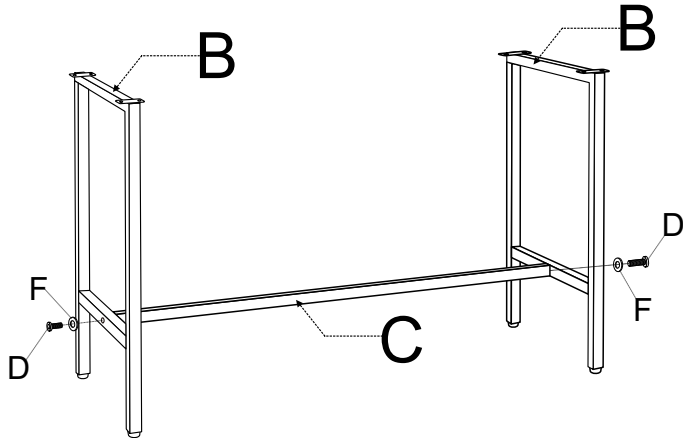

**2**

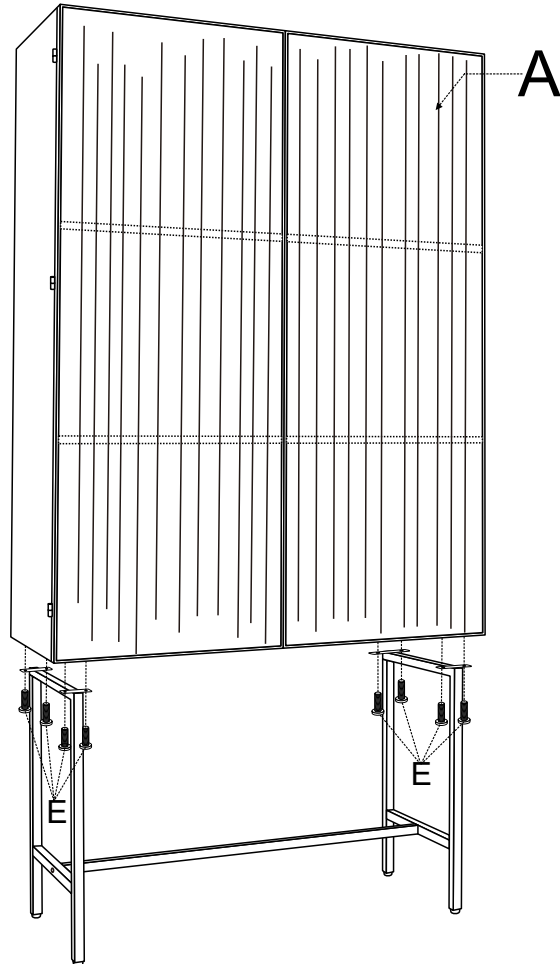

**3**

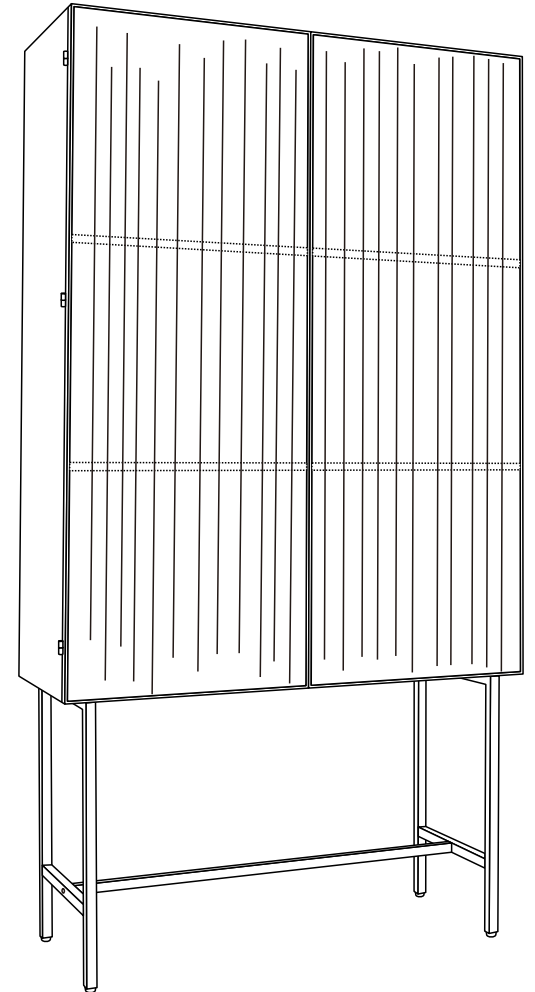

# 87875 Display Cabinet San Diego 90x170cm



Anti tilt system

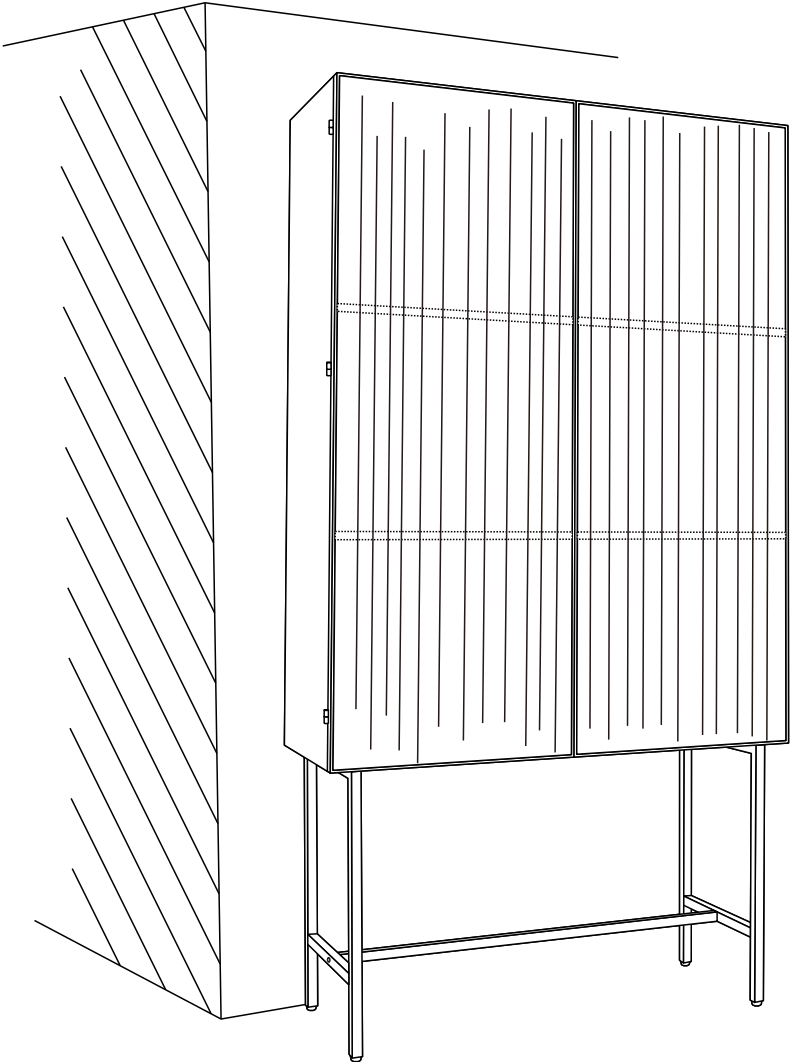

Anti tilt system

a	b	d	e
1PC	2PC	2PC	2PC

