

(1) X 1	
(2) X 2	
(3) X 1	
(4) X 8 (6X16)	
(5) X 2(6X12)	
(6) X 2(6X20)	
(7) X 12 (6X16)	
(8) X 1 (4 MM)	

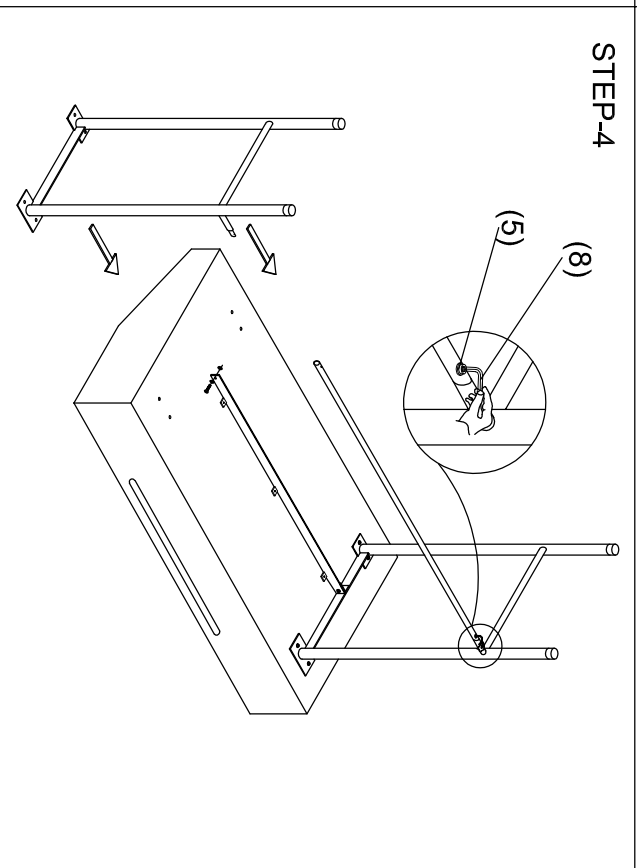

STEP-1

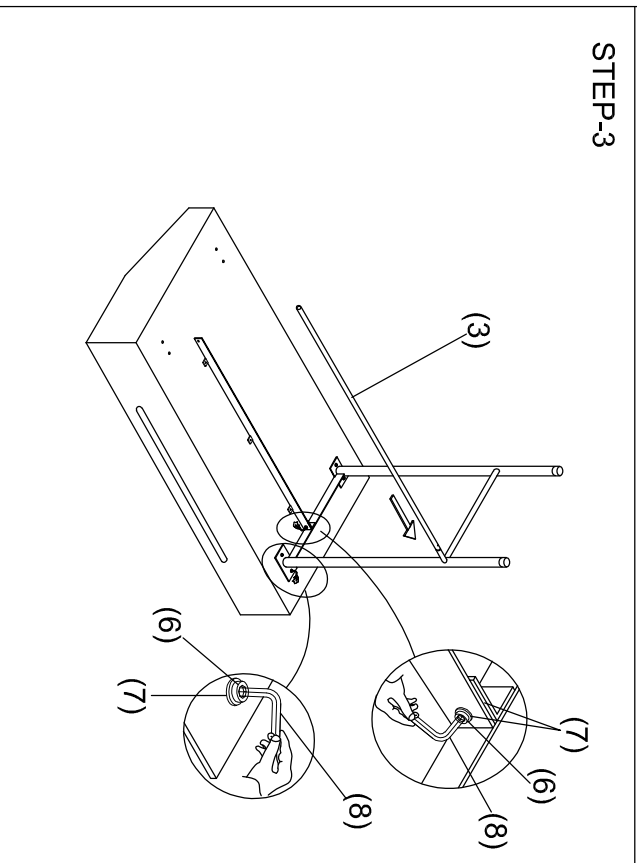
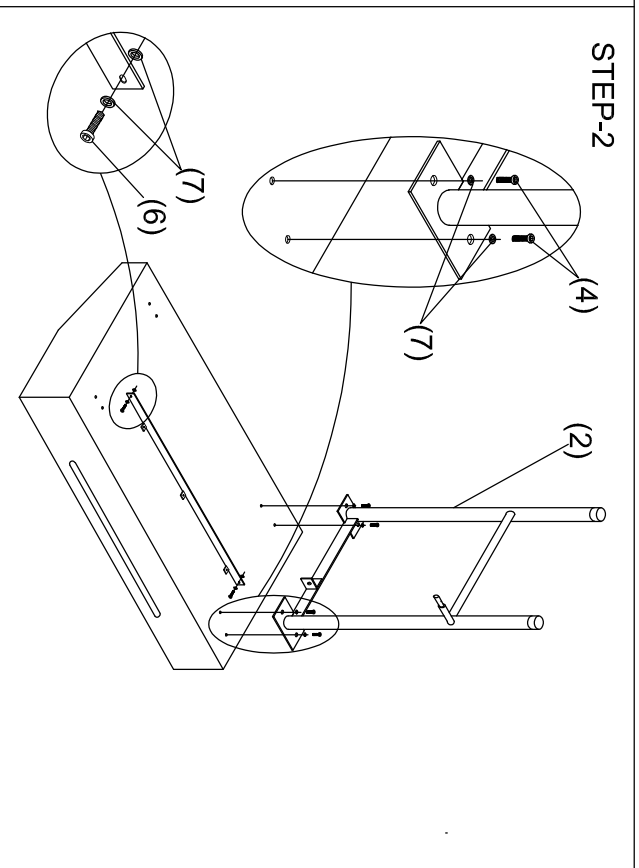
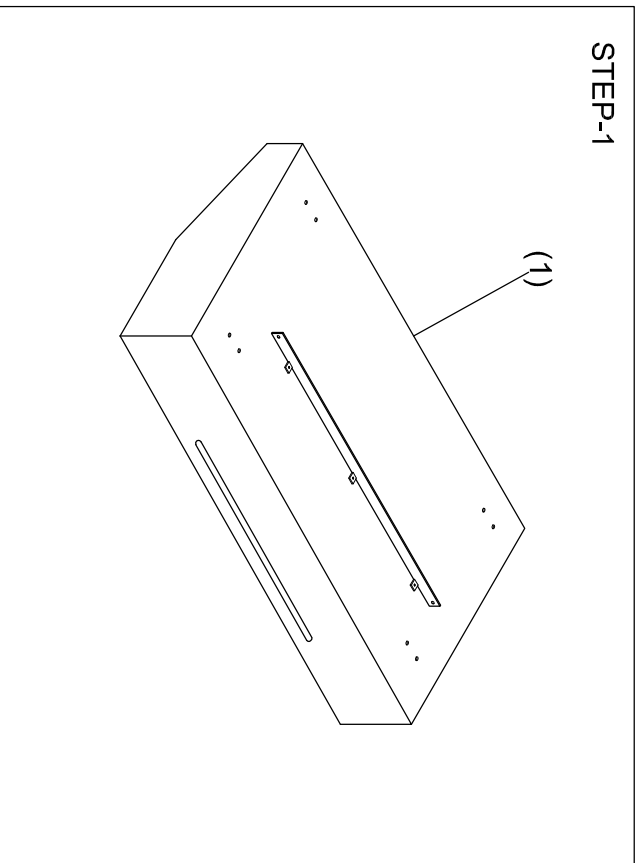
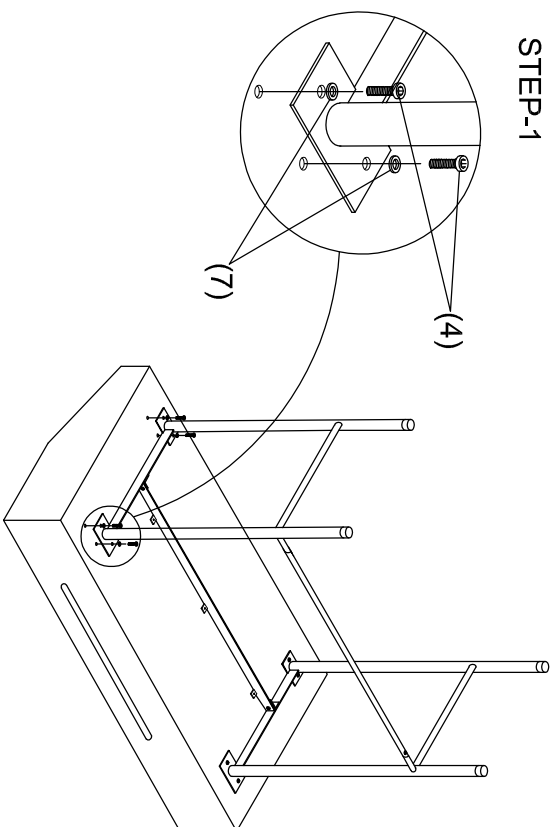

STEP-2

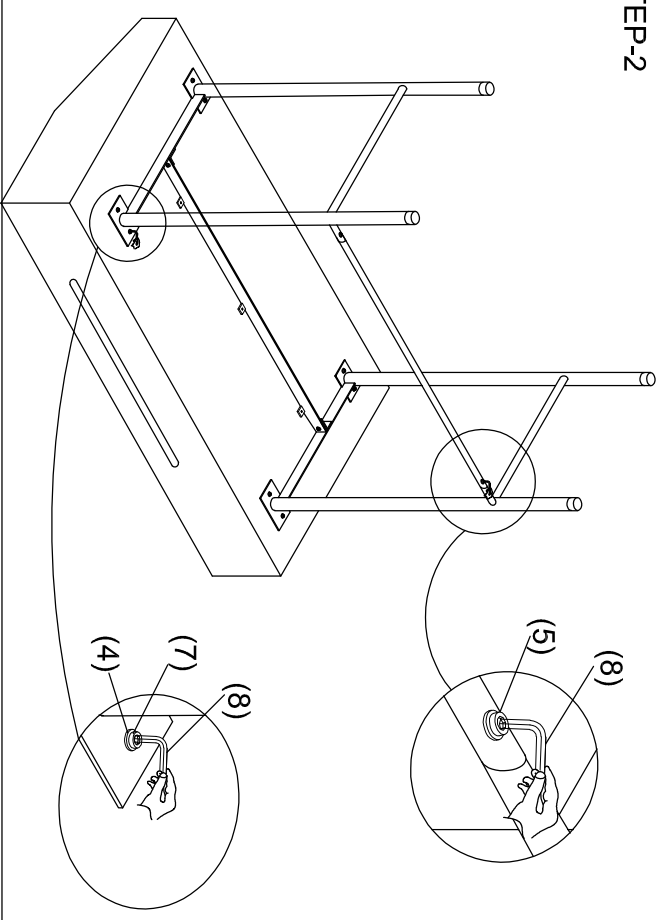

STEP-4

